

INSTRUCTIONS

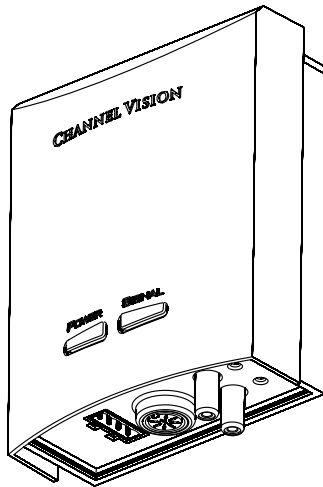

A0240 **40 Watt Stereo Amplifier**

The **A0240** is a 2-channel 40 Watt class D amplifier. It can be used to power a small 1-room audio system or integrated with Channel Vision's A0302 to provide supplemental power to low power distributed audio systems. It's compact size makes it easy to hide and its versatile power plug allows direct wall plug-in or tabletop operation using the detachable power cable. With its easy installation and operation, the A0240 is perfect for any audio system that just needs a little more power.

Features:

- 40 Watts per channel
- Compact size
- Audio-sensing power shut off to conserve energy
- Easy installation

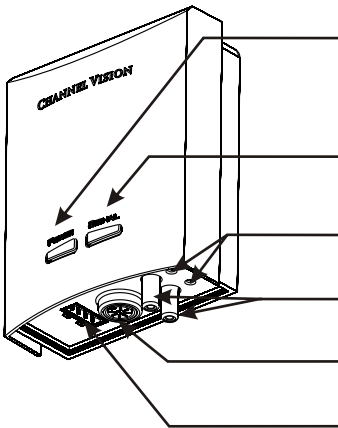

Power LED
Lights when power is on

Signal LED
Lights when input signal is present

L/R Line Level Input Adjustments
Adjust to limit the maximum input level

L/R Line Level Inputs
Connect source output here

Amp-Link
Connect to Channel Vision's A0302

Speaker Outputs
Connect speaker wires here

Amp-Link Cable (included)

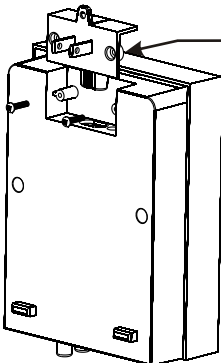

Removable Power Plug
Allows direct plug in, or can be removed and replaced with the standard power cable.

Power Cable (included)



Accessories (sold separately)

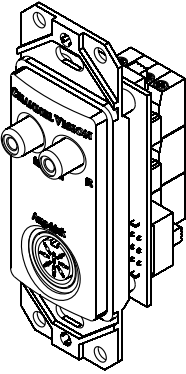

A0302... Speaker to Line-Level Converter

The A0302 can convert the speaker-level output of an audio amplifier to a line-level output that can be used to drive A0240

Complementary Products (sold separately)

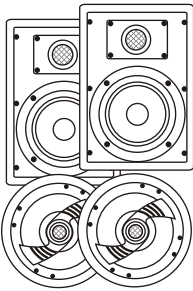

In-wall and In-ceiling Speakers... Channel Vision offers a full line of premium in-wall and in-ceiling speakers. These speakers are perfect for whole-house music or home theater applications.

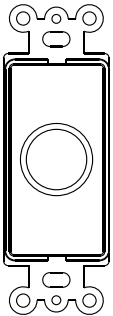

VC-302... Impedance Matching Volume Control

The VC-302 is an impedance matching volume control with an IR receiver knockout. The knockout allows Channel Vision's IR-2400 to be integrated with the volume control for applications that require IR repeating. The VC-302 comes with white, ivory, and almond knobs and face plates to easily match other wall plates in the room.

Using the A0240 with the A0302

The A0302 is the perfect complement to Channel Vision's A0240 amplifier. It can utilize the Amp-Link connection, which provides a clean way to interrupt the speaker-level audio from a low-power system and output 35 Watts per channel to the speakers. This is the perfect way to add power to low-power distributed audio systems.

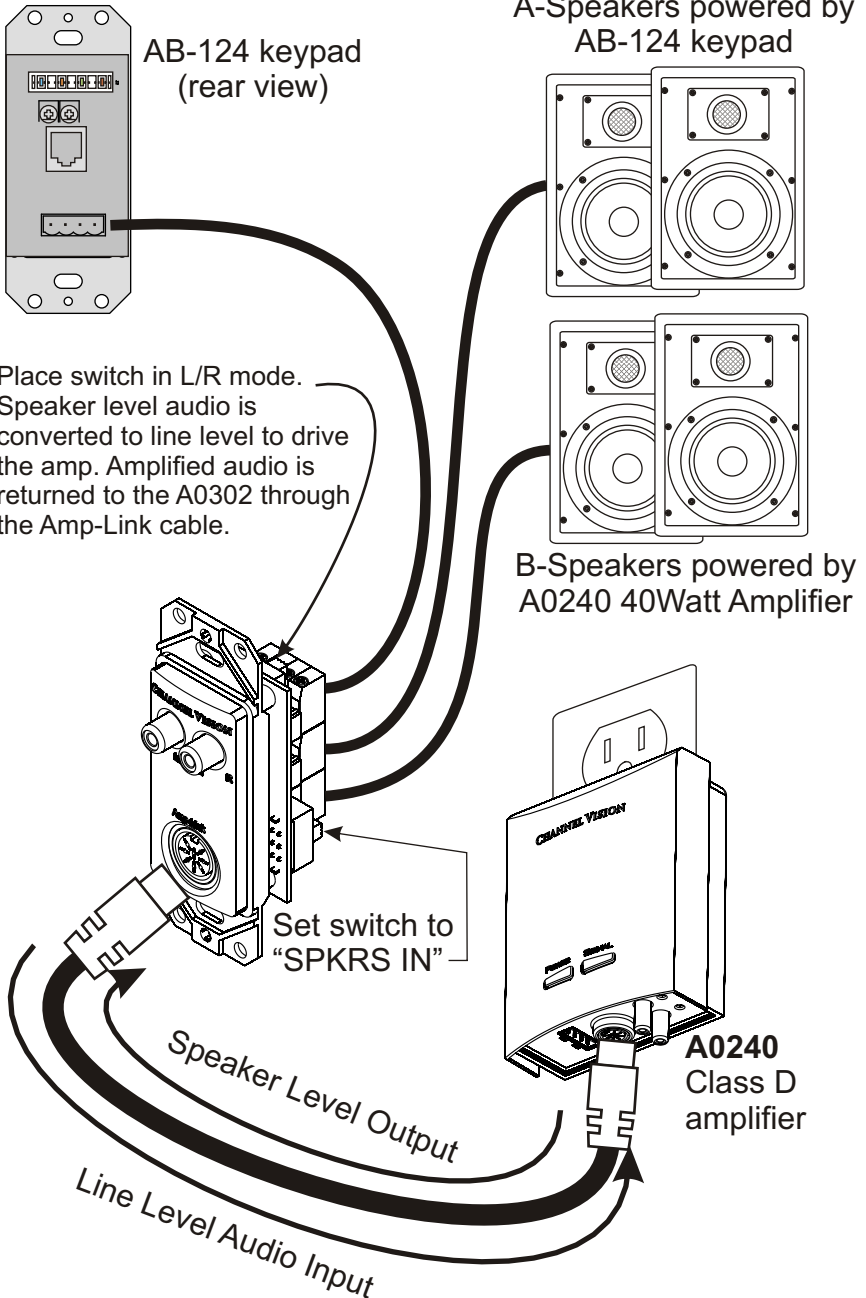

Using the A0240 as a local input amplifier

In addition to increasing power of a distributed audio system, the A0240 can also be used to interrupt a the whole house audio source and amplify a local source device.

Whole-House
Audio System

Place switch in L/R mode.
Speaker level audio is
converted to line level to drive
the amp. Amplified audio is
returned to the A0302 through
the Amp-Link cable.

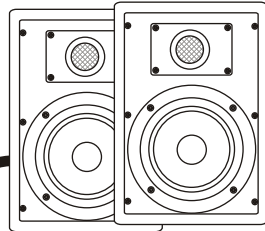

Speakers powered by
A0240 40Watt Amplifier

A0240

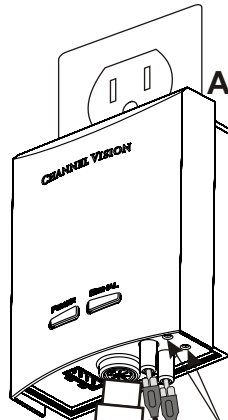

Set switch to
"SPKRS IN"

Speaker Level
Output

Line Level Audio Input

Local Source Audio

Adjust trim pots set the
local source input sensitivity

Note: Local source audio devices should have a variable audio output. Use the volume control on the device to change the volume level in the speakers. Portable music players and TVs are often used as local source devices.

Using the A0240 with the HP-300 and HP-350

The A0240 is the perfect amplifier to use with Channel Vision's new HomePlug audio devices. The HP-300 transmitter distributes your audio source through your home's electrical wiring and the HP-350 receiver outputs the audio to an amplifier, such as the A0240.

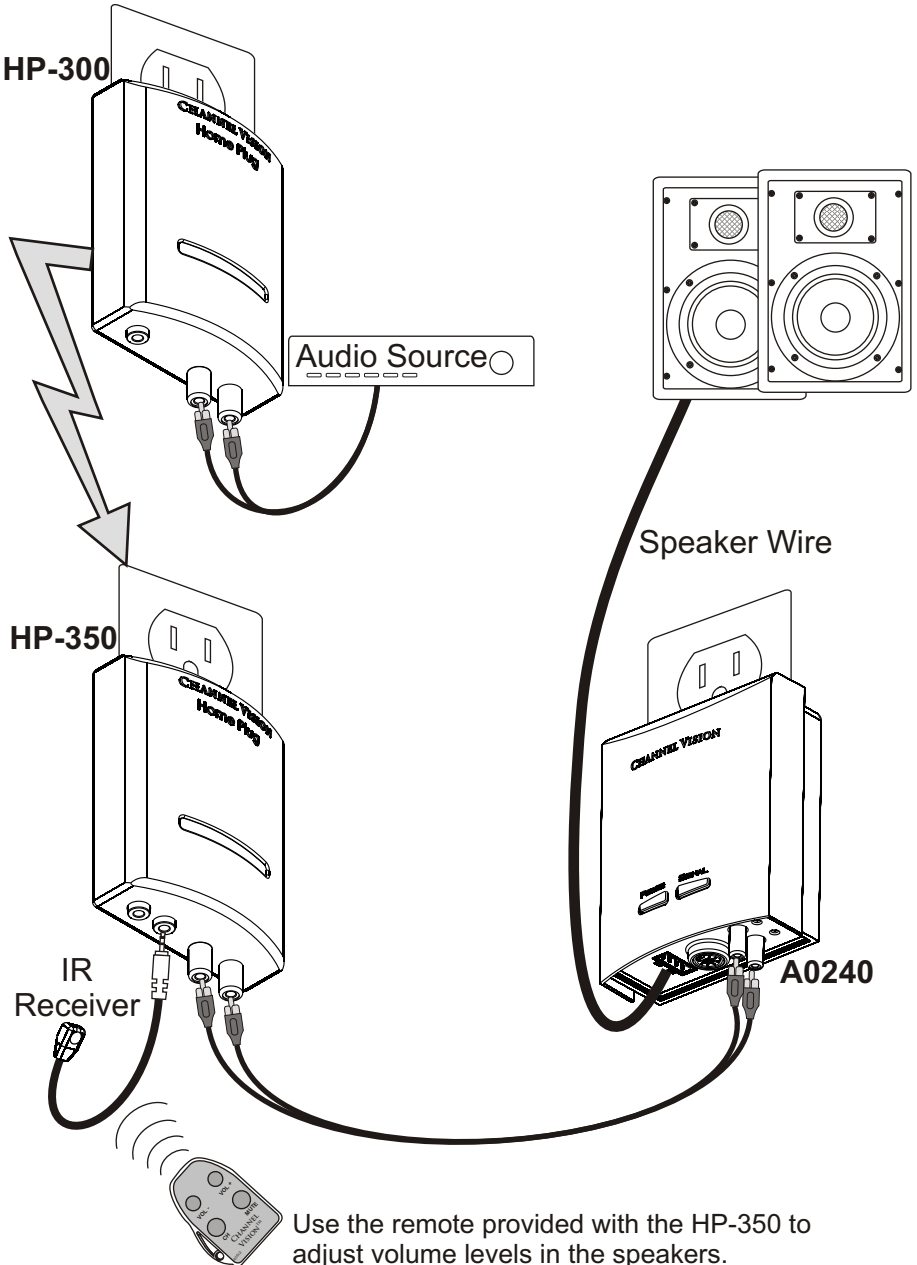

Amp-Link Pin Out

The A0240 provides a special Amp-Link connection that is intended to be used with Channel Vision A0302 wall plate. The pin out is provided here for reference.

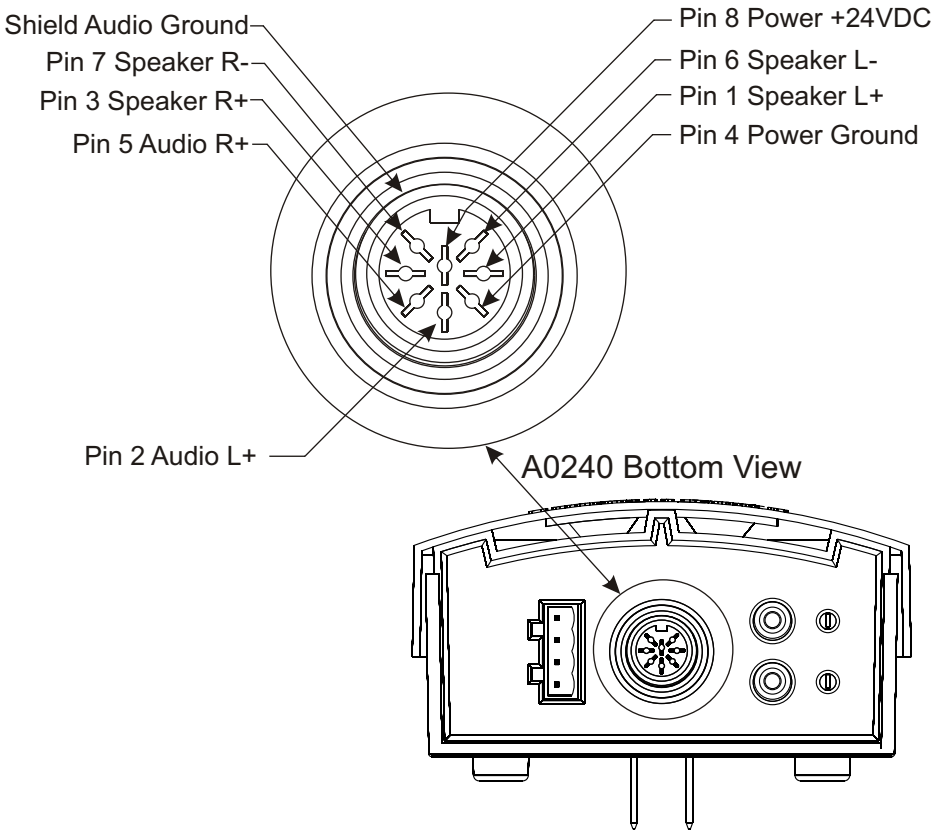

Specifications: (typical at 25 degrees C)

Power input:	110 - 240VAC, 50/60Hz
Output power:	40 Watts/channel RMS into 6 ohms @ <4% THD
Frequency Response:	20-20kHz (+/-3dB)
Signal to Noise Ratio:	>85dB
Input Sensitivity:	500mVRMS
Auto On Threshold:	10mVRMS

Specifications subject to change without notice



2 Year Limited Warranty

Channel Vision Technology will repair or replace any defect in material or workmanship which occurs during normal use of this product with new or rebuilt parts, free of charge in the USA, for two years from the date of original purchase. This is a no hassle warranty with no mail in warranty card needed. This warranty does not cover damages in shipment, failures caused by other products not supplied by Channel Vision Technology, or failures due to accident, misuse, abuse, or alteration of the equipment. This warranty is extended only to the original purchaser, and a purchase receipt, invoice, or other proof of original purchase date will be required before warranty repairs are provided.

Mail in service can be obtained during the warranty period by calling (800) 840-0288 toll free. A Return Authorization number must be obtained in advance and can be marked on the outside of the shipping carton.

This warranty gives you specific legal rights and you may have other rights (which vary from state to state). If a problem with this product develops during or after the warranty period, please contact Channel Vision Technology, your dealer or any factory-authorized service center.



www.channelvision.com

234 Fischer Avenue, Costa Mesa, California 92626 USA

(714)424-6500 • (800)840-0288 • (714)424-6510 fax

email: techsupport@channelvision.com